



Decorative Bedding

Designed to make you
feel at home



Solutions for any style and budget

View our comprehensive collections:



Essentials

Attractive Essentials designs provide a budget-friendly combination of durability and patient comfort.



Signature

Distinctive Signature designs make any space feel like home with a wide range of styles, patterns, and colors.



Exclusive

Top-tier Exclusive designs feature innovative finishes as well as full customization of decorative accents.



Why Medline Interiors?

For more than 100 years, we've leveraged our healthcare expertise to introduce cutting-edge textiles that help customers drive efficiency, cost savings and patient satisfaction, without compromising on aesthetics.

Suede Touch



Essentials collection

The suede-like feel of this quilt combines cozy softness and warmth without sacrificing resistance—or budget.



Characteristics

Contents	Face: 100 FR Fibers Fill: 100% Polyester; 5 oz/square yard
Stitch	Onion
Styles	Throw, Reversible Capped, Non-Reversible
Stocked	Yes for Quick-Ship
Sizes	Throw: 81" W x 110" L Capped: 71" W x 102" L
Customizable	No
Antimicrobial**	No

**These antimicrobial properties are built-in to protect the product. This product does not protect users or others against bacteria, viruses, germs or other disease organisms.

Cleaning Instructions

Machine wash warm at 95°F–120°F with like colors, no bleach, tumble dry low, do not dry at elevated temperatures.

Pricing

\$

Flammability

Meets CAN/CGSB 4.2, 27.5

Warranty

1 year

Ordering Information

Item No.	Description	Pkg.
MITQSQPEBT	81" x 110", Throw, Pebble Tan	1 ea
MITQSQZINT	81" x 110", Throw, Zinfandel Red	1 ea
MITQSQPEAT	81" x 110", Throw, Peacoat Blue	1 ea
MITQSQSAGT	81" x 110", Throw, Sage Green	1 ea
MITQSQCHCT	81" x 110", Throw, Chocolate	1 ea
MITQSQPEBC	71" x 102", Capped, Pebble Tan	1 ea
MITQSQZINC	71" x 102", Capped, Zinfandel Red	1 ea
MITQSQPEAC	71" x 102", Capped, Peacoat Blue	1 ea
MITQSQSAGC	71" x 102", Capped, Sage Green	1 ea
MITQSQCHCC	71" x 102", Capped, Chocolate	1 ea

interiors.medline.com | Contact productsupportinteriors@medline.com for complete product information.

Medline Industries, LP | Three Lakes Drive, Northfield, IL 60093 | 1-800-MEDLINE (633-5463)

© 2022 Medline Industries, LP. All rights reserved. Medline is a registered trademark of Medline Industries, LP. MKT19W2965480 / e21972 / 78

Cozy Solids



Essentials collection

“Cozy-up” with a quilt that combines classic warmth with stylish colors without breaking your budget.



Characteristics

Contents	Face: Polyester/Cotton Blend Fill: 100% Bonded EcoPure 5 oz Polyester Fiberfill
Stitch	Diamond
Styles	Throw, Capped, Non-Reversible
Stocked	No
Sizes	Twin, Throw: 81" x 110" Twin, Capped: 71 x 102 Full, Throw: 96" x 116" Queen, Throw: 100" x 118"
Customizable	No
Antimicrobial**	No

**These antimicrobial properties are built-in to protect the product. This product does not protect users or others against bacteria, viruses, germs or other disease organisms.

Cleaning Instructions

Machine wash cold with similar colors in a large capacity machine, gentle cycle. Only non-chlorine bleach when needed. Tumble dry low in a large capacity machine, remove promptly.

Pricing

\$

Warranty

1 year

Ordering Information

Item No.	Description	Pkg.
MIQC71X102GLD	71" x 102", Capped, Twin, Gold	1 ea
MIQC71X102NVY	71" x 102", Capped, Twin, Navy	1 ea
MIQC71X102SVR	71" x 102", Capped, Twin, Silver	1 ea
MIQC81X110GLD	81" x 110", Throw, Twin, Gold	1 ea
MIQC81X110NVY	81" x 110", Throw, Twin, Navy	1 ea
MIQC81X110SVR	81" x 110", Throw, Twin, Silver	1 ea
MIQC96X116GLD	96" x 116", Throw, Full, Gold	1 ea
MIQC96X116NVY	96" x 116", Throw, Full, Navy	1 ea
MIQC96X116SVR	96" x 116", Throw, Full, Silver	1 ea
MIQC100X118GD	100" x 118", Throw, Queen, Gold	1 ea
MIQC100X118NY	100" x 118", Throw, Queen, Navy	1 ea
MIQC100X118SR	100" x 118", Throw, Queen, Silver	1 ea



interiors.medline.com | Contact productsupportinteriors@medline.com for complete product information.

Medline Industries, LP | Three Lakes Drive, Northfield, IL 60093 | 1-800-MEDLINE (633-5463)

© 2022 Medline Industries, LP. All rights reserved. Medline is a registered trademark of Medline Industries, LP. MKT19W2965480 / e21972 / 78

Passage



Signature collection

Our satin finish, channel-style quilt delivers resident comfort with high style.



Characteristics

Contents Face & Backing: 100% Polyester Microfiber
Fill: 100% Polyester

Stitch 2" Channel

Styles Throw, Reversible

Stocked Yes for Quick-Ship

Sizes 70" W x 110" L*

Customizable No

Antimicrobial** No

**These antimicrobial properties are built-in to protect the product. This product does not protect users or others against bacteria, viruses, germs or other disease organisms.

Cleaning Instructions

Machine wash at 120°F with like colors, no bleach, tumble dry low, max 145°F

Pricing

\$\$

Flammability

Meets CAN/CGSB 4.2, 27.5

Warranty

1 year

Ordering Information

Item No.	Description	Pkg.
MIQP70X110SMK	70" x 110", Throw Style, Smoke	1 ea
MIQP70X110SND	70" x 110", Throw Style, Sand	1 ea
MIQP70X110CRB	70" x 110", Throw Style, Caribbean	1 ea
MIQP70X110SEA	70" x 110", Throw Style, Sea	1 ea

interiors.medline.com | Contact productsupportinteriors@medline.com for complete product information.

Morocco



Signature collection

Modern geometric pattern paired with a luxurious fill to suit the most contemporary or transitional environments.



Characteristics

Contents	Face and Backing: 100% Polyester Fill: 100% Polyester
Stitch	Onion
Styles	Non-Reversible
Stocked	No
Sizes	Throw: 71" W x 110" L Capped: 71" W x 108" L
Customizable	Yes
Antimicrobial**	No

**These antimicrobial properties are built-in to protect the product. This product does not protect users or others against bacteria, viruses, germs or other disease organisms.

Cleaning Instructions

Machine wash with synthetic detergent between 140°F–160°F degrees F max, no bleach or fabric softener, tumble dry 105°F–120°F max, 3–5 minutes, avoid tangling.

Pricing

\$\$

Warranty

1 year

Sapphire



Carolina

Cork

Mocha

Spruce

Grey

Buff

Ordering Information

Item No.	Description	Pkg.
MIBM71X110BUF	71" x 110", Throw, Buff	1 ea
MIBM71X110CAR	71" x 110", Throw, Carolina	1 ea
MIBM71X110CRK	71" x 110", Throw, Cork	1 ea
MIBM71X110MCH	71" x 110", Throw, Mocha	1 ea
MIBM71X110SPH	71" x 110", Throw, Sapphire	1 ea
MIBM71X110SPR	71" x 110", Throw, Spruce	1 ea
MIBM71X110GRY	71" x 110", Throw, Grey	1 ea
MIBM71X108BUF	71" x 108", Capped, Buff	1 ea
MIBM71X108CAR	71" x 108", Capped, Carolina	1 ea
MIBM71X108CRK	71" x 108", Capped, Cork	1 ea
MIBM71X108MCH	71" X 108", Capped, Mocha	1 ea
MIBM71X108SPH	71" X 108", Capped, Sapphire	1 ea
MIBM71X108SPR	71" X 108", Capped, Spruce	1 ea
MIBM71X108GRY	71" X 108", Capped, Grey	1 ea

interiors.medline.com | Contact productsupportinteriors@medline.com for complete product information.

Medline Industries, LP | Three Lakes Drive, Northfield, IL 60093 | 1-800-MEDLINE (633-5463)

© 2022 Medline Industries, LP. All rights reserved. Medline is a registered trademark of Medline Industries, LP. MKT19W2965480 / e21972 / 78

City View/City View 2



Signature collection

Classic unquilted pattern in a range of color options to fit any style or design aesthetic.



Ordering Information

Item No.	Description	Pkg.	Item No.	Description	Pkg.
MIBC74X110BSD	74" x 110", Throw, Beach Sand	1 ea	MIBC74X108BSD	74" x 108", Capped, Beach Sand	1 ea
MIBC74X110MZE	74" x 110", Throw, Maize	1 ea	MIBC74X108MZE	74" x 108", Capped, Maize	1 ea
MIBC74X110OGO	74" x 110", Throw, Oregano	1 ea	MIBC74X108OGO	74" x 108", Capped, Oregano	1 ea
MIBC74X110CRE	74" x 110", Throw, Corleone	1 ea	MIBC74X108CRE	74" x 108", Capped, Corleone	1 ea
MIBC74X110SPH	74" x 110", Throw, Sapphire	1 ea	MIBC74X108SPH	74" x 108", Capped, Sapphire	1 ea
MIBC74X110TRF	74" x 110", Throw, Truffle	1 ea	MIBC74X108TRF	74" x 108", Capped, Truffle	1 ea
MIBC74X110TRN	74" x 110", Throw, Tron	1 ea	MIBC74X108TRN	74" x 108", Capped, Tron	1 ea
MIBC74X110WRT	74" x 110", Throw, Warrant	1 ea	MIBC74X108WRT	74" x 108", Capped, Warrant	1 ea
MIBC74X110YGO	74" x 110", Throw, Yugo	1 ea	MIBC74X108YGO	74" x 108", Capped, Yugo	1 ea
MIBC74X110SMK	74" x 110", Throw, Smoke	1 ea	MIBC74X108SMK	74" x 108", Capped, Smoke	1 ea

Additional colors and sizes available, other than those listed.

Characteristics

Contents	Face and Backing: 100% Polyester Microfiber Fill: 100% Polyester
Stitch	Waffle
Styles	Throw (Reversible), Capped, Non-Reversible
Stocked	No
Sizes	Twin Throw: 74" x 110" Twin Capped: 74" x 108"
Customizable	Yes
Antimicrobial**	No

**These antimicrobial properties are built-in to protect the product. This product does not protect users or others against bacteria, viruses, germs or other disease organisms.

Cleaning Instructions

Machine wash with synthetic detergent between 140°F–160°F max, no bleach or fabric softener, tumble dry 105°F–120°F max, 3–5 minutes, avoid tangling.

Pricing

\$\$

Warranty

1 year

interiors.medline.com | Contact productsupportinteriors@medline.com for complete product information.

Medline Industries, LP | Three Lakes Drive, Northfield, IL 60093 | 1-800-MEDLINE (633-5463)

© 2022 Medline Industries, LP. All rights reserved. Medline is a registered trademark of Medline Industries, LP. MKT19W2965480 / e21972 / 78

Cozy Prints



Signature collection

“Cozy-up” with a quilt that combines classic warmth with attractive modern prints.



Oxidized Leaf



**Batik Scroll
Light Blue**



**Batik Scroll
Gray**



Bennet Green



Bennet Tan

Ordering Information

Item No.	Description	Pkg.	Item No.	Description	Pkg.
MIQC71X102SBC	71" x 102", Capped, Batik Scroll Light Blue	1 ea	MIQC96X116BG	96" x 116", Throw, Bennet Green	1 ea
MIQC71X102SGC	71" x 102", Capped, Batik Scroll Gray	1 ea	MIQC96X116BT	96" x 116", Throw, Bennet Tan	1 ea
MIQC71X102BGC	71" x 102", Capped, Bennet Green	1 ea	MIQC100X118SB	100" x 118", Throw, Batik Scroll Light Blue	1 ea
MIQC71X102BTC	71" x 102", Capped, Bennet Tan	1 ea	MIQC100X118SG	100" x 118", Throw, Batik Scroll Gray	1 ea
MIQC81X110SB	81" x 110", Throw, Batik Scroll Light Blue	1 ea	MIQC100X118BG	100" x 118", Throw, Bennet Green	1 ea
MIQC81X110SG	81" x 110", Throw, Batik Scroll Gray	1 ea	MIQC100X118BT	100" x 118", Throw, Bennet Tan	1 ea
MIQC81X110BG	81" x 110", Throw, Bennet Green	1 ea	MIQC120X118SB	120" x 118", Throw, Batik Scroll Light Blue	1 ea
MIQC81X110BT	81" x 110", Throw, Bennet Tan	1 ea	MIQC120X118SG	120" x 118", Throw, Batik Scroll Gray	1 ea
MIQC96X116SB	96" x 116", Throw, Batik Scroll Light Blue	1 ea	MIQC120X118BG	120" x 118", Throw, Bennet Green	1 ea
MIQC96X116SG	96" x 116" Throw, Batik Scroll Gray	1 ea	MIQC120X118BT	120" x 118", Throw, Bennet Tan	1 ea

Characteristics

Contents	Face and Backing: 70% Polyester, 30% Cotton Fill: EcoPure polyester fiberfill, made from recycled bottles
Stitch	Diamond
Styles	Capped and Throw
Stocked	No
Sizes	Twin Capped: 71" x 102" Twin Throw: 81" x 110" Full: 96" x 116" Queen: 100" x 118" King: 120" x 118"
Customizable	Yes
Antimicrobial**	No

**These antimicrobial properties are built-in to protect the product. This product does not protect users or others against bacteria, viruses, germs or other disease organisms.

Cleaning Instructions

Machine wash cold with similar colors in a large capacity machine, gentle cycle. Only non-chlorine bleach when needed. Tumble dry low in a large capacity machine, remove promptly.

Pricing

\$\$

Warranty

1 year

interiors.medline.com | Contact productsupportinteriors@medline.com for complete product information.

Grassfields



Signature collection

Colorful and elegant, full scale landscape pattern with striated background lends an organic flair to contemporary environments.

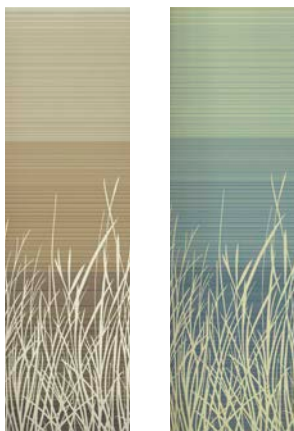

Spring

Summer

Characteristics

Contents	Face and Backing: 5 oz. Bonded Polyester Fill: 5 oz. bonded polyester
Stitch	Onion
Styles	Throw and Capped, Non-Reversible
Stocked	No
Sizes	Twin Capped: 70" x 108" Twin Throw: 70" x 110"
Customizable	Yes
Antimicrobial**	No

**These antimicrobial properties are built-in to protect the product. This product does not protect users or others against bacteria, viruses, germs or other disease organisms.

Cleaning Instructions

Machine wash warm between 120°F–150°F max with like products, no bleach or fabric softener, tumble dry medium, remove promptly from dryer.

Pricing

\$\$

Warranty

1 year

Ordering Information

Item No.	Description	Pkg.
TNT70X108GRFC	70" X 108", Twin, Capped	1 ea
TNT70X110GRFT	70" X 110", Twin, Throw	1 ea

Please specify color when ordering.

interiors.medline.com | Contact productsupportinteriors@medline.com for complete product information.

Signature collection

Elevate your space with this traditional floral pattern quilt that doesn't skimp on quality.



Jardin Blue



Jardin Taupe



Jardin Brown

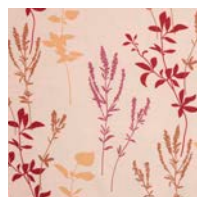

Jardin Burgundy

Characteristics

Contents	Face: Ultra-durable 100% Trevia Polyester, Backing: 50% Cotton/50% Polyester Fill: 5.5 oz/SY 100% Bonded Polyester
Stitch	Channel
Styles	Non-Reversible, Capped and Throw
Stocked	No
Sizes	Twin Capped: 71" x 102" Twin Throw: 80" x 108" Full: 96" x 110" Queen: 102" x 115" King: 120" x 115"
Customizable	Yes
Antimicrobial**	No

**These antimicrobial properties are built-in to protect the product. This product does not protect users or others against bacteria, viruses, germs or other disease organisms.

Cleaning Instructions

Machine wash warm, do not bleach, tumble dry low, 130°F delicate cycle, do not iron, dry clean for best results.

Pricing

\$\$

Warranty

1 year

Ordering Information

Item No.	Description	Pkg.
MCDLX71X102C	71" x 102", Capped, Twin	1 ea
MCDLX80X108	80" x 108", Throw, Twin	1 ea
MCDLX96X110	96" x 110", Throw, Full	1 ea
MCDLX102X115	102" x 115", Throw, Queen	1 ea
MCDLX120X115	120" x 115", Throw, King	1 ea

Please specify color when ordering.

interiors.medline.com | Contact productsupportinteriors@medline.com for complete product information.

Hotel Boutique



Signature collection

Elevate your space with hospitality-quality prints that combine elegant style with durability.



Dinosaur Eggs Lavender



Dinosaur Eggs Beige

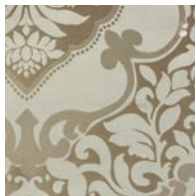

Fiora Multi

Characteristics

Contents Face: 100% Polyester
Backing: 50% Cotton/50% Polyester Blend
Fill: 5.5 oz/SY

Stitch Channel

Styles Non-Reversible, Capped and Throw

Stocked No

Sizes Twin Capped: 71" x 102"
Twin Throw: 80" x 108"
Full: 96" x 110"
Queen: 102" x 115"
King: 120" x 115"

Customizable Yes

Antimicrobial** No

**These antimicrobial properties are built-in to protect the product. This product does not protect users or others against bacteria, viruses, germs or other disease organisms.

Cleaning Instructions

Machine wash warm, do not bleach, tumble dry low, 130°F delicate cycle, do not iron, dry clean for best results.

Pricing

\$\$

Warranty

1 year

Ordering Information

Item No.	Description	Pkg.
MCDHB71X102C	71" x 102", Capped, Twin	1 ea
MCDHB80X108	80" x 108", Throw, Twin	1 ea
MCDHB96X110	96" x 110", Throw, Full	1 ea
MCDHB102X115	102" x 115", Throw, Queen	1 ea
MCDHB120X115	120" x 115", Throw, King	1 ea

Please specify color when ordering.

interiors.medline.com | Contact productsupportinteriors@medline.com for complete product information.

Mission



Exclusive collection

High-quality, unquilted bedspread with a modern geometric pattern and antimicrobial treatment for infection protection.



Denim



Doe

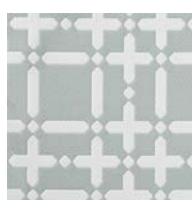

Dove

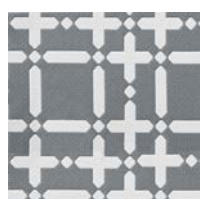

Gunmetal



Olive



Sandal

Characteristics

Contents	100% Polyester
Stitch	N/A
Styles	Non-Reversible, Capped and Throw
Stocked	No
Sizes	Twin Capped: 77" W x 108" L Twin Throw: 74" W x 110" L
Customizable	Yes
Antimicrobial**	No

**These antimicrobial properties are built-in to protect the product. This product does not protect users or others against bacteria, viruses, germs or other disease organisms.

Cleaning Instructions

Machine wash with synthetic detergent between 140°F–160°F degrees F max, no bleach or fabric softener, tumble dry 105°F–120°F max, 3–5 minutes, avoid tangling.

Pricing

\$\$\$

Warranty

1 year

Ordering Information

Item No.	Description	Pkg.
MIBS77X108DNM	77" x 108", Capped, Denim	1 ea
MIBS77X108DOE	77" x 108", Capped, Doe	1 ea
MIBS77X108DVE	77" x 108", Capped, Dove	1 ea
MIBS77X108GNM	77" x 108", Capped, Gunmetal	1 ea
MIBS77X108OLV	77" x 108", Capped, Olive	1 ea
MIBS77X108SDL	77" x 108", Capped, Sandal	1 ea
MIBS74X110DNM	74" x 110", Throw, Denim	1 ea
MIBS74X110DOE	74" x 110", Throw, Doe	1 ea
MIBS74X110DVE	74" x 110", Throw, Dove	1 ea
MIBS74X110GNM	74" x 110", Throw, Gunmetal	1 ea
MIBS74X110OLV	74" x 110", Throw, Olive	1 ea
MIBS74X110SDL	74" x 110", Throw, Sandal	1 ea

interiors.medline.com | Contact productsupportinteriors@medline.com for complete product information.

Safety



Behavioral Health collection

Don't sacrifice comfort where safety matters.



Safety Quilt

Face	500 Denier Nylon Cordura
Back	Knit Polyester
Fill	Hollow siliconized polyester fiber wadding
Stitch Pattern	Channel
Size	Full, Capped, Non-Reversible
Stocked	Yes for Quick-Ship

Cleaning Instructions: Machine wash warm, do not bleach, tumble dry low, 130°F delicate cycle, do not iron, do not dry clean.

Ordering Information

Item No.	Description	Pkg.
MDTSB6S33SAFE	Behavioral Health Fitted Quilt, 36"W x 84"L x 10"D	1 ea



Safety Blanket

Face	500 Denier Nylon Cordura
Back	Knit Polyester
Fill	Hollow siliconized polyester fiber wadding
Stitch Pattern	Diagonal Waffle
Size	Full, Reversible, Throw
Stocked	Yes for Quick-Ship

Cleaning Instructions: Machine wash warm, do not bleach, tumble dry low, 130°F delicate cycle, do not iron, do not dry clean.

Ordering Information

Item No.	Description	Pkg.
MDTSB6S34SAFE	56" x 80", Quilted Safety Blanket, Nylon/Poly	1 ea

interiors.medline.com | Contact productsupportinteriors@medline.com for complete product information.

Looking for something custom? We've got you covered



- 1 Pillow Sham**
Offers additional back and neck support while seated in bed, as well as decorative flair
- 2 Primary Pillow and Pillowcase**
Pillows add comfort for a good night's sleep while pillowcases protect pillows from stains, dust, and dirt transfer
- 3 Decorative Pillow**
Tie together room decor while adding an extra layer of comfort
- 4 Quilt/Bedspread**
Primary source of warmth and comfort
- 5 Fitted Sheet**
The core of bed linens, adds a base layer of comfort while keeping mattresses clean
- 6 Bed Scarf***
Decorative accent that also promotes longevity of quilts by protecting them from things like clothes and shoes
- 7 Bolster Pillow**
Adds lumbar support for extra comfort
- 8 Bed Skirt***
Conceals bed frame for a more tailored look

*Sized based on mattress size.



Fit is everything

Use our simple measuring guide to ensure a snug fit on tailored, capped-style quilts and plenty of drop for a more casual, throw style look.

Fit options:

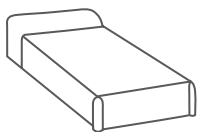

Throw
Belled corners allow for flexibility in both mattress and drop length

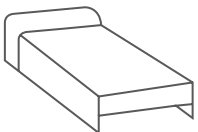

Capped
Sewn corners create a neat, tailored look

Fabric options:



Quilted
Two layers of fabric sewn together with a fill layer in between



Unquilted
Single layer of fabric with no additional fill

Standard mattress sizes:

Twin XL
39" x 80"



Full
54" x 75"



Queen
60" x 80"

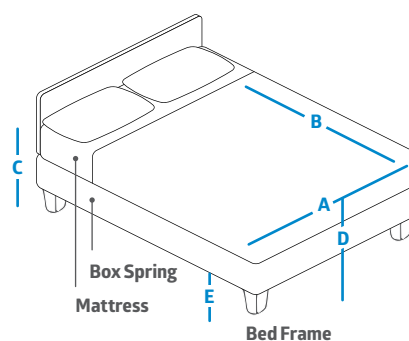
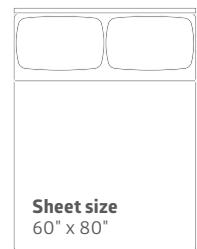

- A** Mattress width
- B** Mattress length
- C** Side drop length
- D** Foot drop length
- E** Bed skirt drop length

Bring your space to life

We have all of the flat good items you need to fully customize your bedding, from sheets and bed skirts to pillows and throw blankets—and everything in between.



We have everything you need

We also carry **healthcare grade furniture** from beds to overbed tables, case goods, accessories and more. Contact productsupportcapital@medline.com or your Medline representative.

Contact your Medline representative to request samples.
Call 1-800-MEDLINE or visit interiors.medline.com to learn more.



**We make
healthcare
run better™**

Medline Industries, LP
Three Lakes Drive, Northfield, IL 60093
Medline United States | 1-800-MEDLINE (633-5463)
medline.com | info@medline.com

Medline Canada
1-800-268-2848 | medline.ca | canada@medline.com
Medline México
01-800-831-0898 | medlinemexico.com | mexico@medline.com

Follow us    